

Empfangsbereiche:
 17-51m
 200-580m
 750-2000m

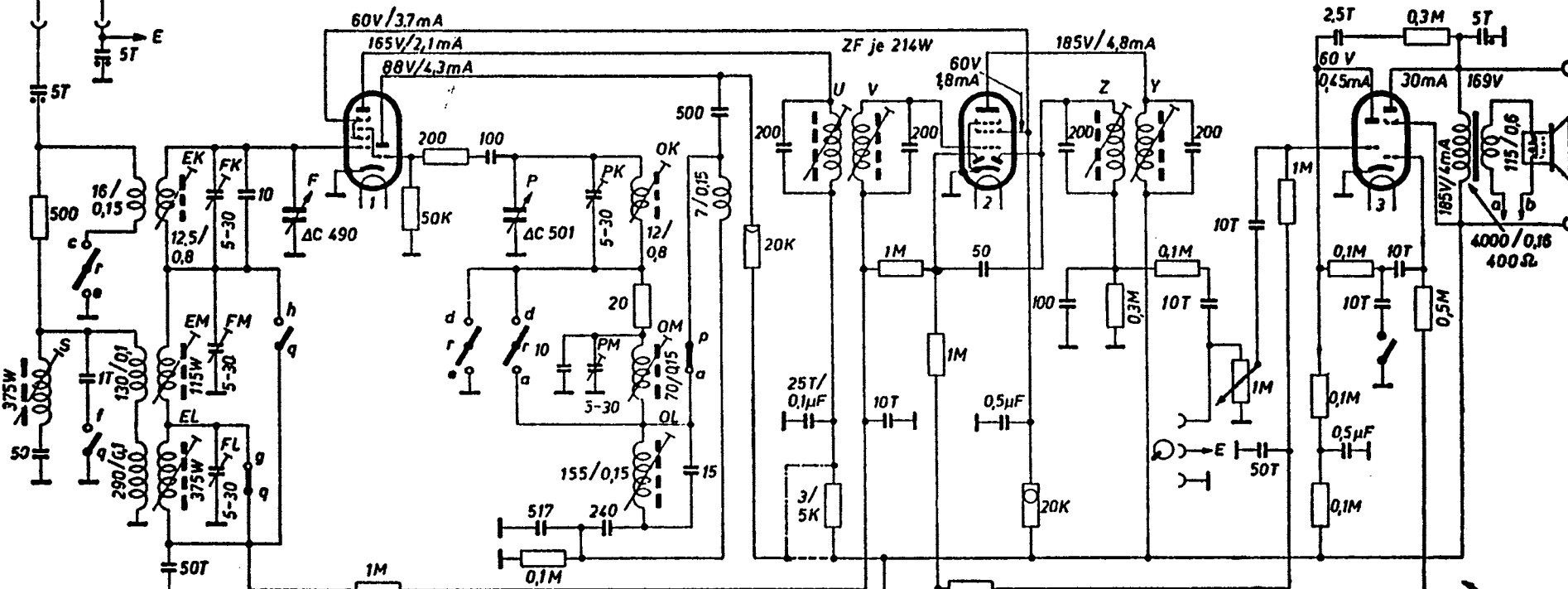

→	a	c	d	e	f	g	h
K	r	r	r			q	
M	p					q	
L	r	r	r			q	

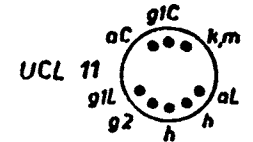
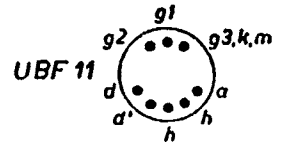
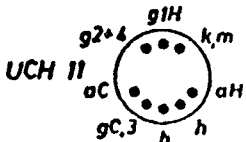
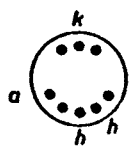

UY 11
 Kompens. Wicklg. 20/016
 Drossel 3800/0,12 500Ω
 (Feld 11000/0,13 1100Ω)

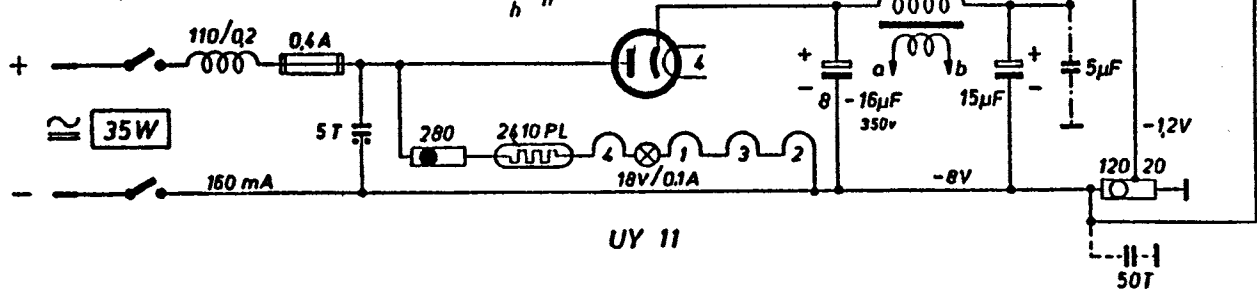

UY 11

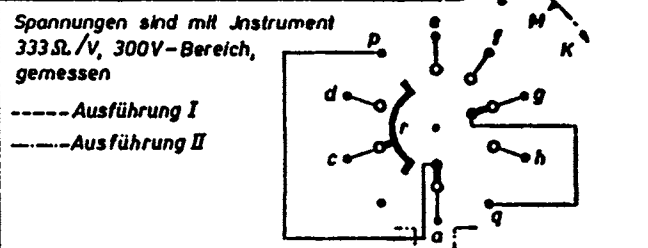

Ansicht von Stator-Lötseite

ZF = 468 kHz